

20

24

Dünya'da ilk!!

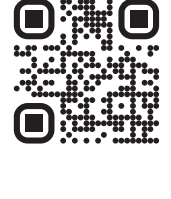

moparsa.com

MOPARSA

Mobilya Parça Sanayi ve Arge San. Tic. Ltd. Şti

Demonte olan
her türlü panel mobilyaları

- Mutfak Modülleri
- Ray Dolap
- Çekmeceler
- Kitaplık
- Banyo Dolapları
- Modüler Mobilyalar

CNC Router'da imal ediyorsanız

CNC ROUTER'DA

CNC ROUTERİNİZ VAR MI? ✓

MODÜLLERİ VİDA İLE Mİ
TOPLUYORSUNUZ?

MİNİFİKSLİ KONNEKTÖR
KULLANMAK İSTER MİSİNİZ?

KONNEKTÖRLERDE GÜÇ
PROBLEMİ Mİ YAŞIYORSUNUZ?

MERKEZLEME SIKINTISI Mİ
YAŞIYORSUNUZ?

MONTAJ ÇOK MU ZAMANINIZI
ALİYOR?

O zaman sizin için!

UNIFIXIT

FIXIT



Konnektör Ailesi

FIXT[®]



UNIFIXT[®]



AYNI PANELDE KULLANILDIĐINDA



✓ MERKEZLENMELİ

✓ EKONOMİK

✓ GÜÇLÜ

✓ SAĐLAM

MONTAJ İMKANI SUNAR

FIXT Konnektör Ailesi sayesinde panel mobilya imalatçları kullanım yerine göre sökülebilen/sökülemeyen modeller arasında tercih yapabilecektir.



SİPARİŞ KODLARI

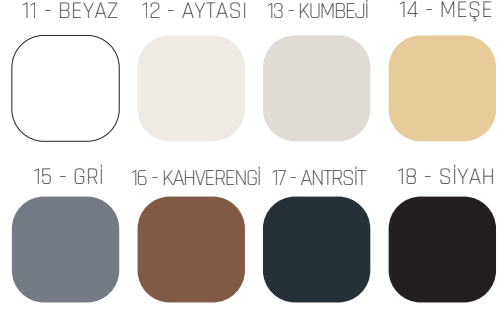
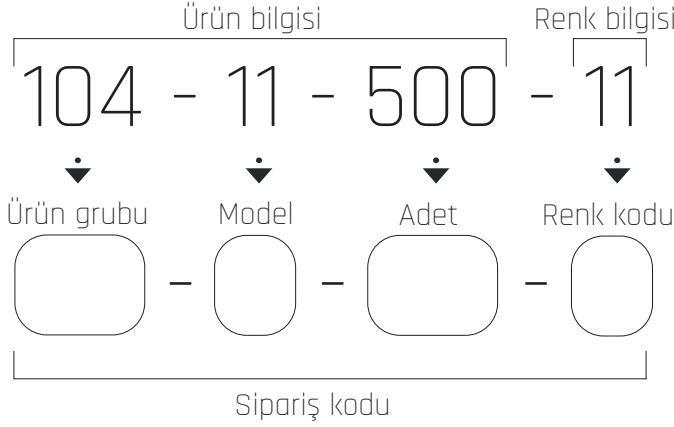

Siparişlerde; MOPARSA Katalogundaki sipariş kodu, rengi-malzemesi, ölçüleri eksiksiz ve tam olmalıdır.



www.moparsa.com

+90 532 060 52 44

info@moparsa.com



Lütfen siparişlerinizi e-ticaret adresimizden veriniz

ÇALIŞMA KOŞULLARIMIZ

- Katalogta bulunan ürünlerin bazıları Patentli, Faydalı model ve Endüstriyel tasarım tescil belgedir.
- Fiyatlarımıza K.D.V Dahil Değildir.
- Siparişleriniz ödeme dekontuyla beraber işleme alınır.
- Siparişlerinizde sevkiyat süresini stok miktarımız belirler.
- Nakliye bedeli alıcıya aittir.
- Firmamızın yazılı izni olmadan herhangi bir kopyalama işlemi kesinlikle yapılamaz.
- Firmamız, haber vermeksizin fiyatları ve satış şartlarını değiştirme hakkını saklı tutar.
- Her yeni fiyat listesi bir öncekini geçersiz kılar.
- Ürün görsellerindeki şekil, renk, ölçü, baskıdan doğan yazım hataları, yanlışlar ve genel tipografik hatalardan firmamız sorumlu değildir.
- Firmamız gerekli gördüğü hallerde, önceden haber vermeksizin modellerde renk, ölçü, form, teknik değişiklik yapma veya üretimden tamamen kaldırma yetkisine sahiptir.

MOPARSA MOBİLYA PARÇA VE ARGE SANAYİ TİCARET LİMİTED ŞİRKETİ

₺ IBAN TR370020500009818868600001 \$ IBAN TR530020500009818868600101

UNIFIXT®

CNC ROUTER'A ÖZGÜ KONNEKTÖR AİLESİ

MİNİFİKSİLİ MODEL M-34



104-11-500-11

18mm Suntaya uygundur



TEKNİK BİLGİLER



CNC ROUTER
TEZGAHLARINA
TAM UYUM ✓

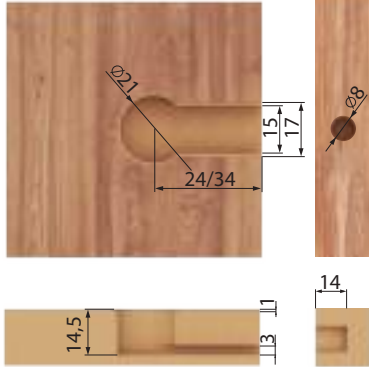

CAM
PROGRAMLARI
İLE TAM UYUM ✓

UNIFIXT
T - KANAL
FREZE ÇAKISI
560-10-1



GÖVDEYİ
DÜZ TABLA
CNC'DE KESİP
MİNİFİKS İLE
TOPLAYANLAR
İÇİN

KONNEKTÖR MONTAJININ
HIZLI VE KOLAY OLMASI ✓

MİNİFİKS'İN KULLANILDIĞI
HER YERDE KULLANMA İMKANI ✓



BİLİNER EN GÜÇLÜ KONNEKTÖR UNIFIXT!



Designed by



ADEKO
TECHNOLOGIES

tarafından tasarlandı

MOPARSA®
Mobilya Parça Sanayi ve Arge San. Tic. Ltd. Şti

UNIFIXT®

CNC ROUTER'A ÖZGÜ KONNEKTÖR AİLESİ

MİNİFİKS Lİ MODEL M-34

SİPARİŞ KODLARI

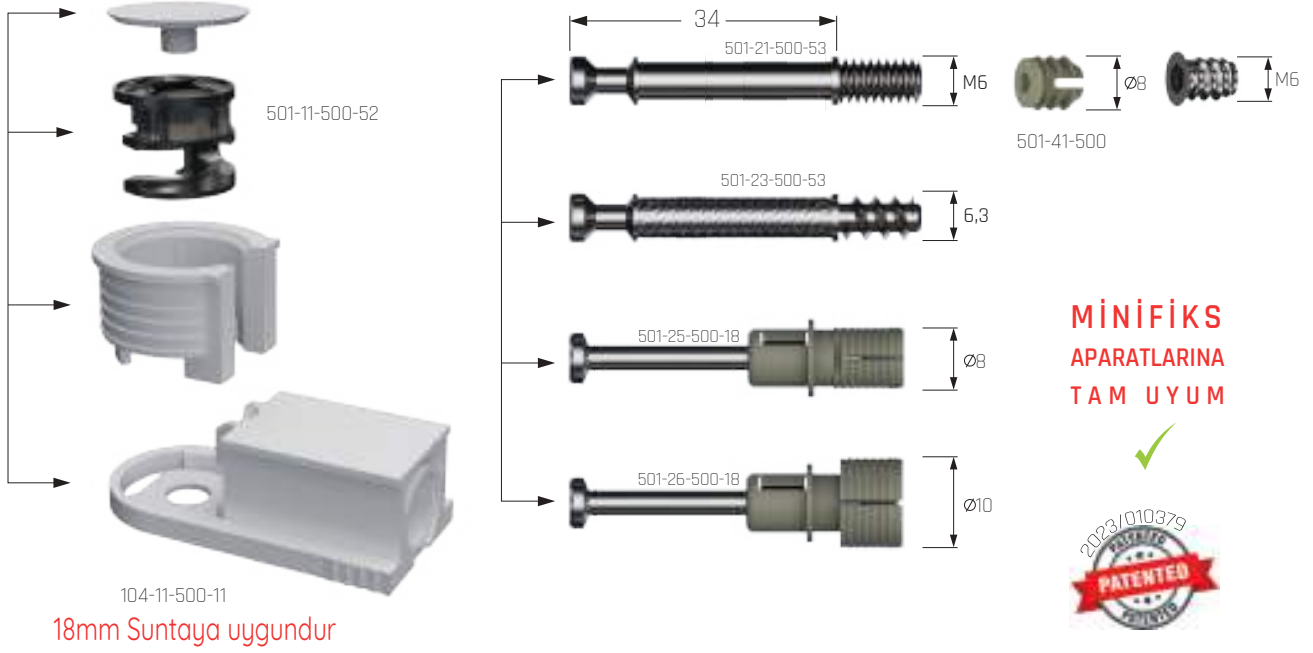

18mm Suntaya uygundur

UNIFIXT - M-34

ÜRÜN KODU	RENK	TANIM	KUTU/KOLİ	KG.	KOLİ m ³
104-11-500	11, 12, 13, 14 15, 16, 17	M-34 - GOVDE + FLANŞ + KAPAK	500 / 5.000	8	0.08
501-11-500	NIKEL - 52 ÇİNKO - 53	12' LİK MİNİFİKS GÖVDE	500 / 5.000	8	0.08

MİNİFİKS MİLLERİ

ÜRÜN KODU	RENK	TANIM	KUTU/KOLİ	KG.	KOLİ m ³
501-21-500	ÇİNKO - 53	M6 / 34 mm MİNİFİKS MİLİ	500 / 5.000	8	0.08
501-23-500	ÇİNKO - 53	6,3 mm EURO / 34 mm MİNİFİKS MİLİ	500 / 5.000	8	0.08
501-25-500	18	Ø8 x 34 mm MİNİFİKS MİLİ	500 / 5.000	8	0.08
501-26-500	18	Ø10 x 34 mm MİNİFİKS MİLİ	500 / 5.000	8	0.08

DÜBELLER

ÜRÜN KODU	RENK	TANIM	KUTU/KOLİ	KG.	KOLİ m ³
501-41-500	11, ZAMAK - 54	M6 - Ø8 x 13 mm	500 / 5.000	8	0.08
501-42-500	11, ZAMAK - 54	M6 - Ø10 x 13 mm	500 / 5.000	8	0.08

11 - BEYAZ 12 - AYTASI 13 - KUMBEJİ 14 - MEŞE 15 - GRİ 16 - KAHVERENGİ 17 - ANTRSİT 18 - SİYAH



Designed by



ADEKO
TECHNOLOGIES

tarafından tasarlandı

MOPARSA®
Mobilya Parça Sanayi ve Arge San. Tic. Ltd. Şti

UNIFIXT®

CNC ROUTER'A ÖZGÜ KONNEKTÖR AİLESİ

MİNİFİKS Lİ MODEL M-24

SİPARİŞ KODLARI



18mm Suntaya uygundur



**MİNİFİKS
APARATLARINA
TAM UYUM**



UNIFIXT - M-24

ÜRÜN KODU	RENK	TANIM	KUTU/KOLİ	KG.	KOLİ m ³
103-11-500	11, 12, 13, 14 15, 16, 17	UNIFIXT -M-24-GOVDE-BEYAZ	500 / 5.000	8	0.08
501-11-500	NIKEL - 52 ÇİNKO - 53	12' LİK MİNİFİKS GÖVDE	500 / 5.000	8	0.08

MİNİFİKS MİLLERİ

ÜRÜN KODU	RENK	TANIM	KUTU/KOLİ	KG.	KOLİ m ³
501-22-500	ÇİNKO - 53	M6 / 24 mm MİNİFİKS MİLİ	500 / 5.000	8	0.08
501-24-500	ÇİNKO - 53	6,3 mm EURO / 24 mm MİNİFİKS MİLİ	500 / 5.000	8	0.08
501-27-500	18	Ø8 x 24 mm MİNİFİKS MİLİ	500 / 5.000	8	0.08
501-28-500	18	Ø10 x 24 mm MİNİFİKS MİLİ	500 / 5.000	8	0.08

DÜBELLER

ÜRÜN KODU	RENK	TANIM	KUTU/KOLİ	KG.	KOLİ m ³
501-41-500	11, ZAMAK - 54	M6 - Ø8 x 13 mm	500 / 5.000	8	0.08
501-42-500	11, ZAMAK - 54	M6 - Ø10 x 13 mm	500 / 5.000	8	0.08



Designed by



ADEKO
TECHNOLOGIES

tarafından tasarlandı

MOPARSA®
Mobilya Parça Sanayi ve Arge San. Tic. Ltd. Şti

5

UNiFiXt[®]

CNC ROUTER'A ÖZGÜ KONNEKTÖR AİLESİ

KULLANIM AVANTAJLARI

CNC
ROUTER
KULLANIRKEN
MİNİFiKS
ALİŞKANLIĞINIZDAN
VAZGEÇMEYİN

KANALLI YAPI
SAYESİNDE YÜK
TAŞIMA SIKINTISI
ÇÖZÜLDÜ

UNiFiXt!

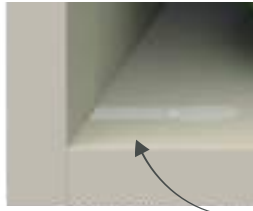
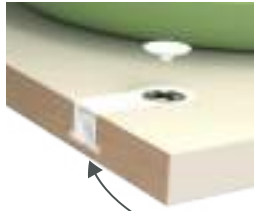

CNC ROUTER'A ÖZGÜN TASARIM SAYESİNDE

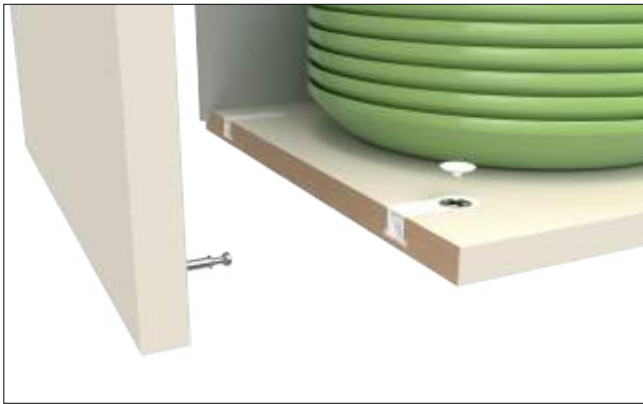
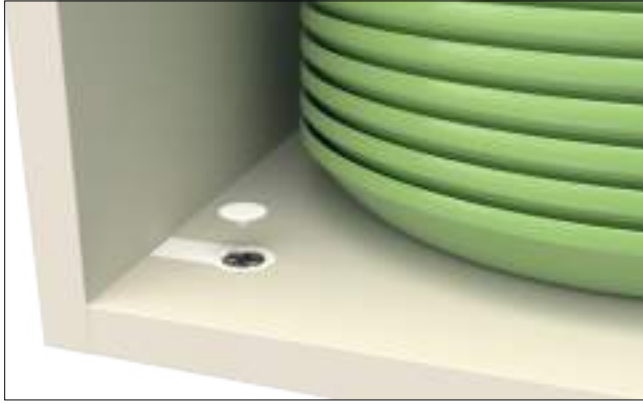

✓ Panel renklerinde üretim ile
görünürlüğün azaltılması

✓ Panellerin yük taşıma kapasitesinde
büyük oranda artış

✓ Panellerin demonte paket gönderiminde,
panel ve konnektörlerin
yüzey bütünlüğü sayesinde
zarar görmesi önlendi

✓ Kilitli ve kanallı yapısıyla
panellerin konnektör ile
montajı güçlendi

✓ Panellerin hızlı ve bilinen
montaj kolaylığı sağlandı

✓ Güçlü gövde yapısı ile
sınırsız sök tak imkanı



Designed by



ADEKO
TECHNOLOGIES

tarafından tasarlandı

MOPARSA[®]
Mobilya Parça Sanayi ve Arge San. Tic. Ltd. Şti

UNIFIXT®

CNC ROUTER'A ÖZGÜ KONNEKTÖR AİLESİ

MİNİFİKSLİ MODEL M-34

KULLANIM AVANTAJLARI

Demonte olan her türlü panel mobilyalarda

- ✓ Mutfak Modülleri
- ✓ Çekmeceler
- ✓ Banyo Dolapları
- ✓ Ray Dolap
- ✓ Kitaplık
- ✓ Modüler Mobilyalar

CNC ROUTER'da
2.yüz işleme
problemi çözüldü

Artık tek yüz işleme RayDolap imal edebilirim **UNIFIXT!**

İki sabit rafı 1 mil
ve 2 UNIFIXT ile
sabitleyebilirim



2. yüzdeki sabit rafı
UNIFIXT ile
sabitleyebilirim



UNIFIXT ile güçlü
ve hızlı montaj
yapabilirim



UNIFIXT yüzeye
sabitleyebilirim



UNIFIXT yüzden
montaj yapabilirim



104-11-500-11



Designed by



ADEKO
TECHNOLOGIES

tarafından tasarlandı

MOPARSA
Mobilya Parça Sanayi ve Arge San. Tic. Ltd. Şti

UNiFiXt[®]

CNC ROUTER'A ÖZGÜ KONNEKTÖR AİLESİ

VİDALI MODEL V-28

YAN DELİK İHTİYACI YOK



105-11-500-11

18mm Suntaya uygundur



TEKNİK BİLGİLER

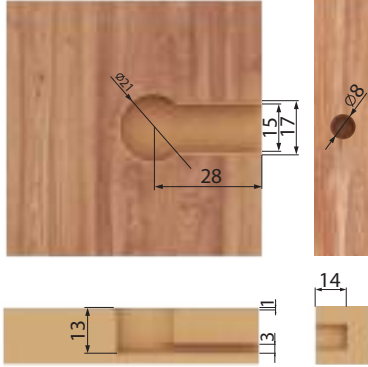

CNC ROUTER TEZGAHLARINA TAM UYUM



CAM PROGRAMLARI İLE TAM UYUM



UNiFiXt T - KANAL FREZE ÇAKISI 560-10-1



CNC ROUTELA KESİP ÇİVATA İLE TOPLAYANLAR İÇİN

KONNEKTÖR MONTAJININ HIZLI VE KOLAY OLMASI



PANELLERİN GÜÇLÜ MONTAJI

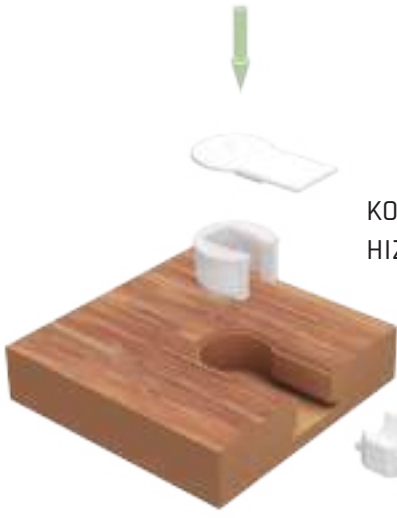

BİLİNER EN GÜÇLÜ KONNEKTÖR UNiFiXt!



Designed by



ADEKO TECHNOLOGIES

tarafından tasarlandı

MOPARSA[®]
Mobilya Parça Sanayi ve Arge San. Tic. Ltd. Şti



UNIFIXT®

CNC ROUTER'A ÖZGÜ KONNEKTÖR AİLESİ

SİPARİŞ KODLARI

VİDALI MODEL V-28



105-11-500-11

18mm Suntaya uygundur



**CİVATA
ÇEŞİTLERİ
İLE MONTAJ
İMKANI**



UNIFIXT - V-28

ÜRÜN KODU	RENK	TANIM	KUTU/KOLİ	KG.	KOLİ m ³
105-11-500	11, 12, 13, 14 15, 16, 17	V-28 - GOVDE + FLANŞ - V + KAPAK	500 / 5.000	8	0.08

CİVATA ÇEŞİTLERİ

ÜRÜN KODU	RENK	TANIM	KUTU/KOLİ	KG.	KOLİ m ³
551-01-500	ÇİNKO - 53	M6 ALYAN BAŞLI CİVATA	500/5.000	8	0.08
551-02-500	ÇİNKO - 53	M6 TORNAVİDA BAŞLI CİVATA	500/5.000	8	0.08
551-03-500	ÇİNKO - 53	M6 ALYAN BAŞLI AHŞAP CİVATASI	500/5.000	8	0.08

DÜBELLER

ÜRÜN KODU	RENK	TANIM	KUTU/KOLİ	KG.	KOLİ m ³
501-41-500	11, ZAMAK - 54	M6 - Ø8 x 14 mm	500/5.000	8	0.08
501-42-500	11, ZAMAK - 54	M6 - Ø10 x 14 mm	500/5.000	8	0.08

FREZE ÇAKILARI

ÜRÜN KODU	RENK - MALZEME	TANIM	KUTU/KOLİ	KG.	KOLİ m ³
560-10-1	KARBÜR	UNIFIXT - T KANAL FREZE ÇAKISI Ø12	1/2	0,2	0.08
560-11-1	KARBÜR	FREZE ÇAKISI Ø8	1/2	0,2	0.08



Designed by



ADEKO
TECHNOLOGIES

tarafından tasarlandı

MOPARSA®
Mobilya Parça Sanayi ve Arge San. Tic. Ltd. Şti



UNiFiX'i[®]
BİLİKEN EN GÜÇLÜ
KONNEKTÖR

FIXT®

CNC ROUTER'A ÖZGÜ KONNEKTÖR AİLESİ

Dünya'da ilk !!



101-11-1000-11

18mm Suntaya uygundur

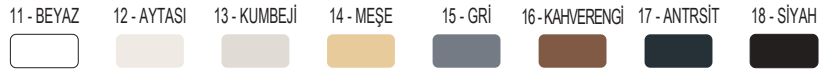

FIXT

ÜRÜN KODU	RENK	TANIM	KUTU/KOLİ	KG.	KOLİ m ³
101-11-1000	11, 12, 13, 14, 15, 16, 17	FIXT -GÖVDE	1.000 / 10.000	8	0.08

TEKNİK BİLGİLER

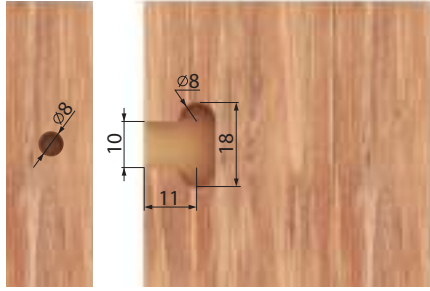

CAM PROGRAMLARI İLE TAM UYUM

FREZE ÇAKISI 560-11-1

YAN DELİK İHTİYACI OLMAYAN KAVELA FIXT!



VİDALI MONTAJDA HIZLI KURULUM

FIXT YARDIMIYLA MERKEZLENME, KABİN VİDASI İLE MONTAJ

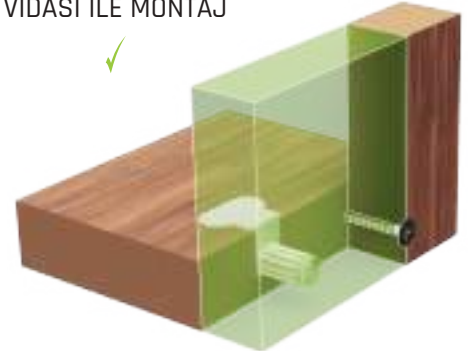
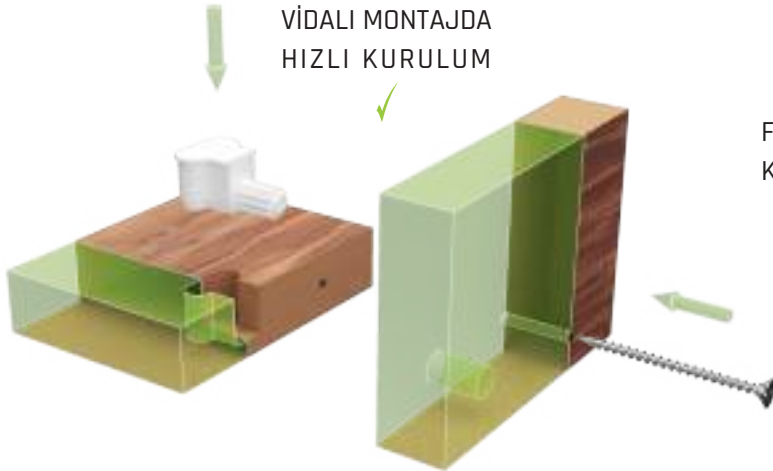

Designed by



ADEKO TECHNOLOGIES

tarafından tasarlandı

MOPARSA®
Mobilya Parça Sanayi ve Arge San. Tic. Ltd. Şti

Dünya'da ilk !!

Sadece bir kavela değil,
modül montajlarınızda
kolay hizalama sağlar

- ✓ Mutfak Modülleri
- ✓ Ray Dolap
- ✓ Çekmeceler
- ✓ Kitaplık
- ✓ Banyo Dolapları
- ✓ Modüler Mobilyalar

Civata yardımı il en güçlü ve sökilemeyen bağlantı **FIXT!**



İŞ GÜCÜNDEN TASARRUF

Tek bir usta modülü toplayabilir,
yardım gerektirmez



MERKEZLER

Sökülebilir konnektörlerin yanında
merkezlenme ve destek için
kullanabilirim



PRATİKTİR

Modüllerin, kalifiye eleman ihtiyacı
olmadan montajını yaptırabilirim



EKONOMİK ÇÖZÜM

Çekmeceleri tekrar sökme
ihtiyacı olmadığı için FIXT ile
toplayabilirim



KAZANDIRIR

Mutfak modüllerini güçlü, hızlı
ve ekonomik olarak üretebilirim



FIXT yüzeye
sabitleyebilirim



FIXT yüzden
montaj yapabilirim



FIXIT®

CNC ROUTER'A ÖZGÜ KONNEKTÖR AİLESİ

GİZLİ MODEL - GM



102-11-500-11

18mm Suntaya uygundur



102-13-500-51

Sunta vidası



CNC
ROUTERLARA
ÖZGÜ İLK
MERKEZLENMELİ
VE VİDALI
KONNEKTÖR

FIXT - GM

11 - BEYAZ

12 - AYTAŞI

13 - KUMBEJİ

14 - MEŞE

15 - GRİ

16 - KAHVERENGİ

17 - ANTRSİT

18 - SİYAH



ÜRÜN KODU	RENK	TANIM	KUTU/KOLİ	KG.	KOLİ m ³
102-11-500	11, 12, 13, 14 15, 16, 17	FIXT -GOVDE + KAPAK	500 / 5.000	8	0.08
102-13-500	METAL - 51	FIXT -GM-M6X13 CİVATA	500 / 5.000	8	0.08

TEKNİK BİLGİLER

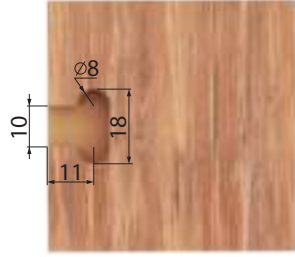
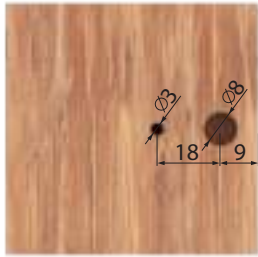

ÇAKMA
APARATI

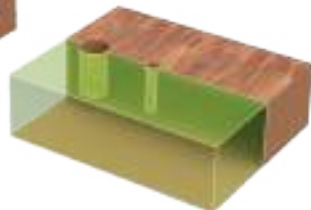

GÖRÜNEN
YANLAR İÇİN
İDEALDİR



Designed by



ADEKO
TECHNOLOGIES

tarafından tasarlandı

MOPARSA®
Mobilya Parça Sanayi ve Arge San. Tic. Ltd. Şti

13

FIXT[®]

CNC ROUTER'A ÖZGÜ KONNEKTÖR AİLESİ

GİZLİ MODEL - GM

KULLANIM ALANLARI VE KAZANIMLARI

Dünya'da ilk !!

- ✓ Mutfak Modülleri
- ✓ Ray Dolap
- ✓ Çekmeceler
- ✓ Kitaplık
- ✓ Banyo Dolapları
- ✓ Modüler Mobilyalar

Kavelanın kuvveti ile
civatanın **gücü birleşti!**

Özgün tasarım sayesinde daha güçlü bağlantı **FIXT!**



İŞ GÜCÜNDEN TASARRUF

Tek bir usta modülü toplayabilir,
yardım gerektirmez



MERKEZLER VE BİRLEŞTİRİR

Konnektör sayesinde **merkezleyerek**
montaj yapabilirim



PRATİKTİR

Modüllerin, **kalifiye eleman**
ihtiyacı olmadan montajını
yaptırabilirim



EKONOMİK ÇÖZÜM

Banyo dolaplarını **ekonomik sunta**
vidası kullanarak montajlayabilirim



FIXT GM yüzeye
sabitleyebilirim



FIXT GM yüzden
montaj yapabilirim



Designed by



ADEKO
TECHNOLOGIES

tarafından tasarlandı

MOPARSA
Mobilya Parça Sanayi ve Arge San. Tic. Ltd. Şti

MOPARSA[®]

Mobilya Parça Sanayi ve Arge San. Tic. Ltd. Şti

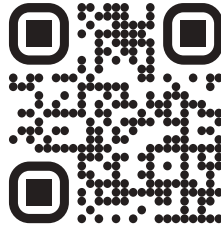

www.moparsa.com

Lütfen siparişlerinizi e-ticaret adresimizden veriniz



+90 532 060 52 44



info@moparsa.com



Tasarım Tescil No:
2022 004714

